

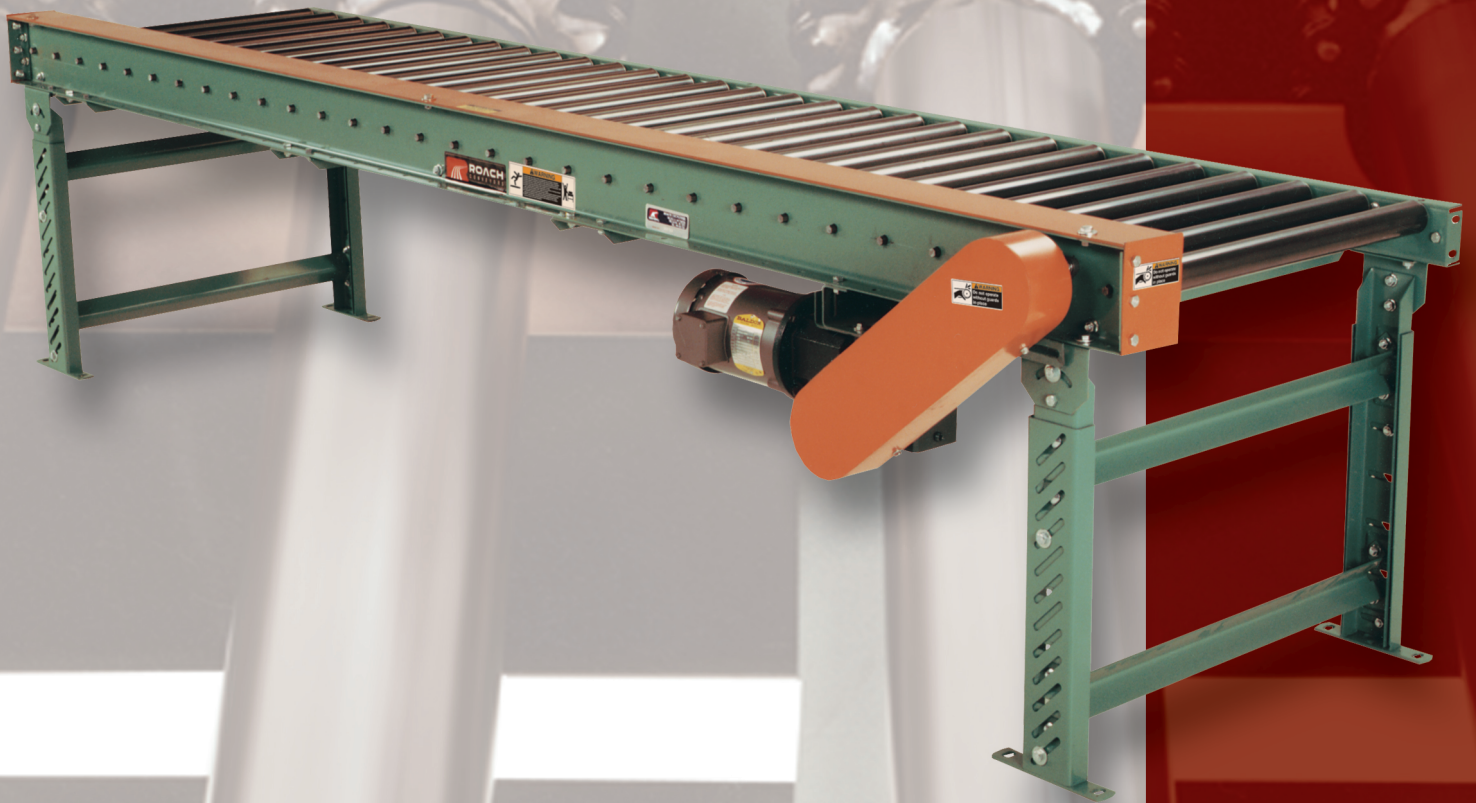

OWNER'S MANUAL



Chain Driven Live Rollers

Model 192CDLR • 251CDLR • 297CDLR • 3530CDLR

DO NOT OPERATE BEFORE READING THIS HANDBOOK
KEEP IN A SAFE PLACE - DO NOT DISCARD

TECH HANDBOOK FOR CDLR

TABLE OF CONTENTS

TECH HANDBOOK FOR CDLR.....	2	TROUBLE SHOOTING AND REPLACEMENT PARTS.....	13
-Warning Labels	2	-Trouble Shooting / Serial Plate.....	13
CAUTIONS, WARNINGS AND HAZARDS	3	MODEL 192CDLR	
-Introduction.....	3	-Parts List.....	14
-Cautions, Warnings and Hazards.....	3	-Underneath and Sidemount Drive Drawings.....	14
SAFETY INFORMATION	4	MODEL 251CDLR	
-Important Safety Guidelines.....	4	-Parts List.....	15
RECEIVING AND INSPECTION	5	-Underneath and Sidemount Drive Drawings.....	15
-Shortages, Damages and Return Authorizations	5	MODEL 251CDLR/297CDLR STRUCTURAL	
-Uncrating.....	5	-Parts List.....	16
GENERAL INSTALLATION INFORMATION.....	6	-Underneath and Sidemount Drive Drawings.....	16
-Attaching Bed Sections.....	6	MODEL 3530CDLR	
-Couplings and Unit Squareness.....	6	-Parts List.....	17
START-UP PROCEDURES	7	-Underneath and Sidemount Drive Drawings.....	17
-Drive Chain and Sprocket Alignment.....	7	NOTES	18
-Drive Chain and Sprocket Tension.....	7	WARRANTY	19
-Gear Reducer Vent Plug.....	8		
-Preparing for Initial Start-Up.....	8		
MAINTENANCE SAFETY PRECAUTIONS	9		
-Before Performing Maintenance.....	9		
-Maintenance and Follow-Up Details	9		
MAINTENANCE AND LUBRICATION	10		
-Periodic Maintenance Schedule	10		
-Recommended Lubricants.....	11		
-Report on Miscellaneous Maintenance Performed	12		

All specifications are subject to change without notice * Drawings are intended for illustration ONLY and are not to scale

WARNING LABELS



ABOVE: Label attached to all protective guards (drives, roller guards, etc.)

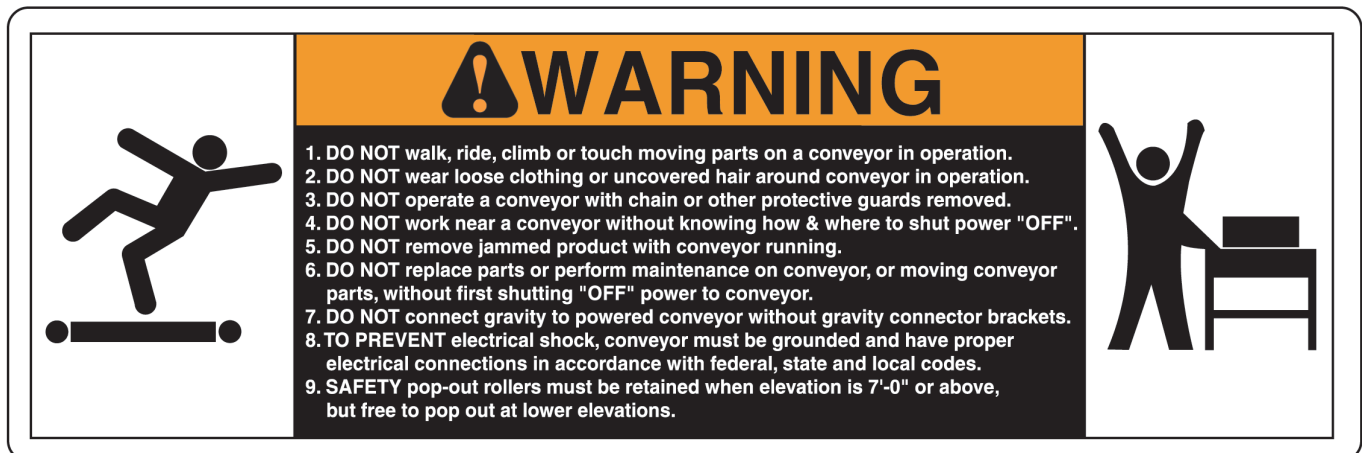

ABOVE: Label placed near all drive assemblies and at 30' intervals

CAUTIONS, WARNINGS AND HAZARDS

INTRODUCTION

This manual was prepared as a “how-to-guide” for installers, end-users and maintenance personnel. It is also intended to educate both owner (purchaser) and all individuals working around the unit, of potential hazards.

With proper installation and maintenance, conveyors are essential for achieving a variety of functions essential in today’s industrial marketplace. By following a simple, periodic maintenance schedule, the life of a typical conveyor (or, most any type of machinery--including our automobiles!) will increase when compared to a similar

unit in an application receiving little or no maintenance. You may find that a conveyor can become your best workplace friend by following simple safety guidelines.

Failure to follow even the most basic safety suggestions can result in serious personal injury.

Conveyors contain many moving parts--pulleys, belting, chains, sprockets, shafts, rollers, etc. Therefore, it is imperative to become familiar with basic unit operation and know all points of potential hazards.

Remember, when working around or near conveyors (and any industrial machinery)

it is **your** responsibility to become familiar with the unit, to know potential hazards (many are noted with caution labels) and to operate unit in strict accordance with the safety guidelines in this manual.

Keep this manual in a safe place for future reference. It should be placed where appropriate personnel may maintain proper maintenance and records.

This manual must be read by all new users before operating or working near this unit.

WARNING

**DO NOT OPERATE BEFORE READING THIS MANUAL!
KEEP IN SAFE PLACE--DO NOT DISCARD!**

CAUTIONS, WARNINGS AND HAZARDS

WARNING

 ALWAYS anchor permanent supports to floor (or mounting surface). Use 3/8" x 2-1/2" (or longer) wedge anchors for permanent installation in concrete flooring.

 It is the responsibility of the customer and installation personnel to supply and install net or mesh guarding on overhead mounted conveyors to prevent product and/or debris from falling to floor in areas where required.

 Center drive guards **MUST** be replaced after installation or maintenance.

 To check drive sprocket alignment, shut “OFF” and lock out power source before attempting any adjustments.

 To check drive sprocket tension, shut “OFF” and lock out power source before any adjustments are attempted.

 Electrical controls must be designed by a qualified electrical engineer to ensure that appropriate safety features (emergency stops, pull cords, switches, etc.) are installed on unit for safe operation. Before conveyor start-up, all operators and other personnel coming in contact with unit must be properly trained and must have read accompanying Tech Handbook.

 Only trained personnel shall perform maintenance functions. Before maintenance operations are performed, shut conveyor “OFF” and lock out power source to prevent unauthorized start-up. When maintenance is completed, only authorized personnel shall be permitted to start conveyor following maintenance or other emergency shut-off.

SAFETY INFORMATION

IMPORTANT SAFETY GUIDELINES

WARNING

WARNING: All personnel coming in contact with this conveyor should be aware of the following safety guidelines **BEFORE USING OR WORKING AROUND CONVEYOR**. **NOTE:** ALWAYS notify Roach Manufacturing® whenever any conveyor is used in an application or condition other than was originally intended. Failure to notify Roach® may allow conveyor to be operated in a hazardous operating condition. Injuries resulting from negligence or violation of safety instructions hereby removes responsibility of product liability claims from Roach®.

 Do not operate conveyor with protective guards removed. This includes chain guards, belt guards, snub roller guards, center drive guards and any other safety guard.

 Do not walk, ride, climb, or touch moving parts on a conveyor in operation.

 Do not wear loose clothing or uncovered hair around conveyor.

 Do not work near conveyor without knowing how & where to shut power "OFF" and lock out power source.

 Do not remove jammed product with conveyor running.

 Do not replace parts or perform maintenance on conveyor, or moving conveyor parts, without first shutting "OFF" power to conveyor and locking out power source.

 Do not connect gravity to powered conveyor without safety gravity connector brackets.

 To prevent electrical shock, conveyor must be grounded, and have proper electrical connections in accordance with federal, state, and local codes.

 Safety pop out rollers in conveyors installed above 7'-0" elevation must be retained by guard rail, clips, etc. Safety pop out rollers must be allowed to pop out

when conveyors are installed at or below 7'-0" elevation.

 It is the responsibility of conveyor end-user to comply with all safety standards including OSHA and other federal, state, and local codes or regulations. Install protective guarding and other related safety precautionary equipment to eliminate hazardous operating conditions which may exist when two or more vendors supply machinery for related use.

 Any violation of above safety instructions hereby removes all product liability claims from Roach Manufacturing Corporation®.

RECEIVING AND INSPECTION

SHORTAGES, DAMAGES AND RETURN AUTHORIZATIONS

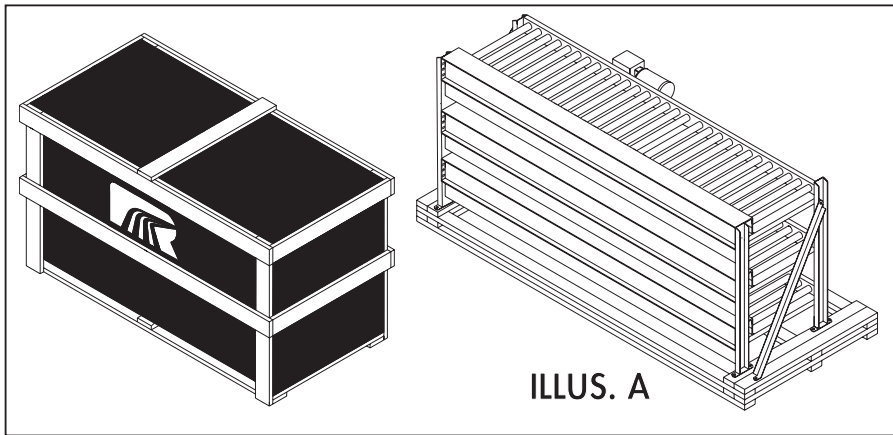

NOTE: Do not return goods to factory without prior, written return authorization. Unauthorized returns are subject to refusal at factory.

Before uncrating, check the quantity of items received against bill of lading to confirm that all material has been received. Examine the condition of the equipment to determine if any damage has occurred.

Also, it is possible that some items may become separated from the original shipment. Therefore, when receiving goods, it is imperative that the bill of lading (or,

accompanying freight documentation) be checked to ensure receipt of ALL units ordered including ALL accessories.

Damage and/or shortage in shipment should be reported immediately to both vendor and carrier. Obtain a signed damage report from carrier agent and send copy to vendor. **Do not repair any damage before obtaining this report.**

For damaged shipments, consult factory to determine if entire shipment must be returned to factory for repair **or** if an immediate order should enter production to produce a new, replacement shipment.

In illustration A above, model 251CDLR is shown palletized, prepared for shipment.

UNCRATING

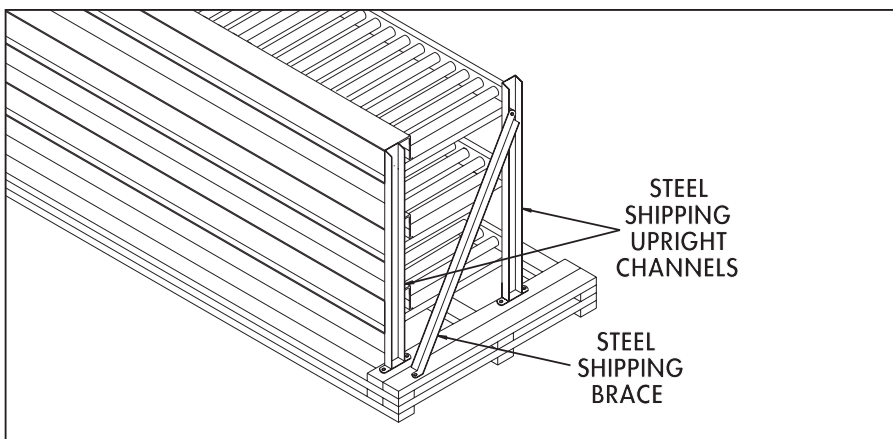

NOTE: Carefully examine shipment during uncrating to ensure that essential components are not discarded. This includes guard rail and other necessary hardware.

After receipt and initial inspection is completed, carefully remove crating and look for essential components and specific accessories that may have been boxed and attached (or 'banded') to crating material. Guard rails and hardware are often packaged and shipped in this manner. Save all hardware for subsequent use by installation personnel.

The drive section will be shipped mounted to its actual operating bed section. Intermediate bed sections are shipped on a common shipping pallet and are attached at the end of bed sections through unit butt couplings with heavy duty steel shipping upright channels.

Some items (electric motors, gearbox, etc.) may be shipped direct from their manufacturer to final destination. Thus, the conveyor may consist of two or more separate shipments.

GENERAL INSTALLATION INFORMATION

ATTACHING BED SECTIONS

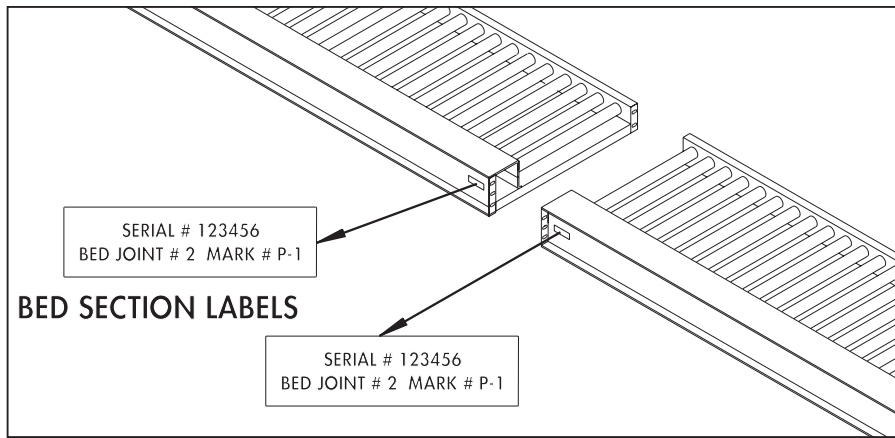

NOTE: It is critical for bed sections to be field assembled in proper sequence following bed section labels..

When preparing to install conveyor, first locate all component sections in the actual installation area. After uncrating, place unit bed sections conveying side up. Each bed section is marked to indicate proper sequence for mating (see illustration above for typical bed section labels).

It is critical for bed sections to be field assembled in proper sequence following

bed section labels. Refer to bed section drawing for location of supports and assemble as shown.

Conveyors are set up at the factory, bed section labels are applied, unit is test run and receives rigorous quality assurance inspection. At this time unit becomes field-ready. Therefore, it is critical that field installation personnel re-assemble unit by

mating beds in accordance with bed section labels (and bed section drawing).

Create a reference base line on floor by marking a chalk line along the centerline of conveyor. Follow base line when installing unit.

COUPLINGS AND UNIT SQUARENESS

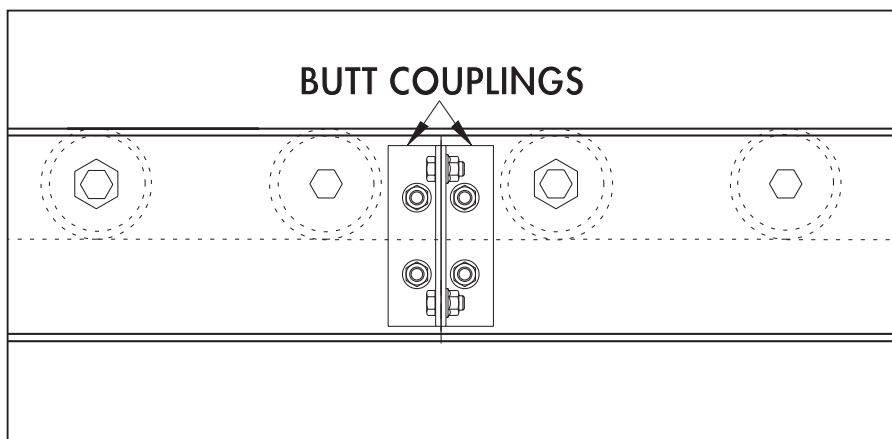

NOTE: During unit installation, take diagonal measurement across unit and make adjustments as necessary to square unit prior to final assembly of supports

Use mechanical hoist (fork truck or other available means) to raise bed sections to approximate elevation to be installed. Mate intermediate sections with butt couplings to join bed sections (see illustration above).

One of the most critical elements of proper installation is unit squareness. During unit installation, take diagonal measurement across unit and make adjustments as necessary to square unit prior to final assembly of supports.

If conveyor is installed with beds not squared, packages will travel to one side of conveyor.

START-UP PROCEDURES

DRIVE CHAIN AND SPROCKET ALIGNMENT

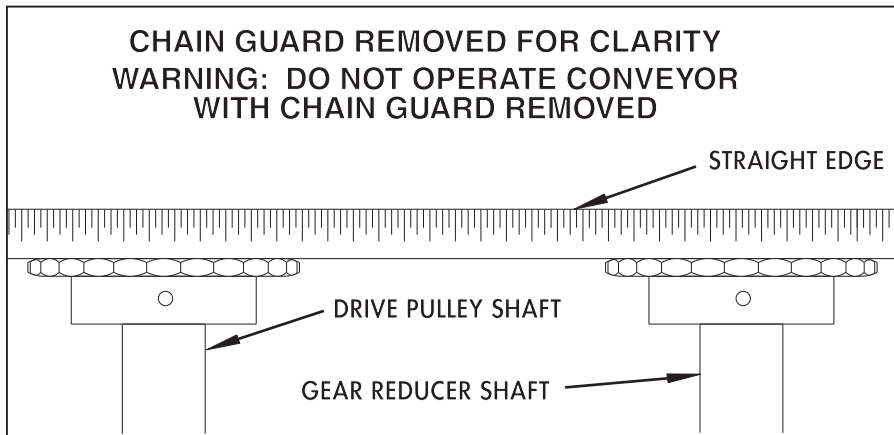

WARNING
Do not operate without guards in place

WARNING

To check drive sprocket alignment, it is imperative that conveyor is shut "OFF" and power source is locked out before any adjustments are attempted.

Set up and maintenance of drive sprocket and drive chain alignment is critical. A periodic visual inspection is recommended to confirm alignment of drive components (which includes both drive sprockets and drive chain). Should set screws become loose, drive sprockets are subject to excessive wear and ultimately, to untimely replacement.

To check drive sprocket alignment, it is imperative that conveyor is shut "OFF" and power source is locked out before any adjustments are attempted. Remove chain guard cover and place straight-edge (see illustration above) across face of both drive sprockets. If re-alignment is necessary, loosen set screws and adjust drive

sprockets as required. Remember to securely tighten set screws when alignment is complete.

Before replacing chain guard cover, check drive chain tension as described in following section, "Drive Chain and Sprocket Tension."

DRIVE CHAIN AND SPROCKET TENSION

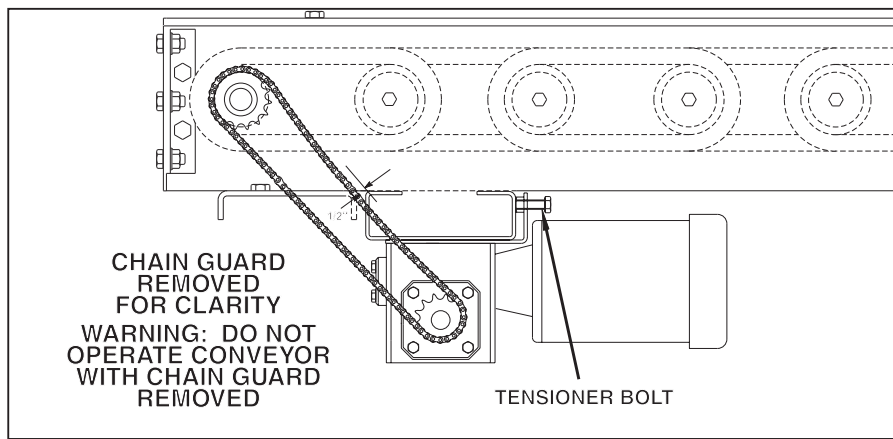

WARNING
Do not operate without guards in place

WARNING

To check drive sprocket tension, shut "OFF" and lock out power source before any adjustments are attempted.

Maintaining proper chain tension is especially important. Again, a periodic visual inspection is recommended to ensure chain tension within a pre-determined operating range.

Remember, before any adjustments are attempted, conveyor must be shut "OFF" and power source locked out.

Before replacing chain guard cover, check

to see if drive chain is operating within 1/2" range (see above illustration). If unit is out of tolerance, adjustment is necessary.

To adjust drive chain tension, tensioner bolt located on reducer push plate should be tightened (rotate clockwise) if chain tension is loose. Tighten until proper operating range is achieved. If chain tension is too tight, loosen tensioner bolt (rotate counter-

clockwise) as required. When adjustment is complete replace chain guard cover.

WARNING: Do not operate unit until chain guard cover is replaced. Serious operator or other personal injury could result if protective guarding is not replaced.

START-UP PROCEDURES[®] GEAR REDUCER WITH POSIVENT

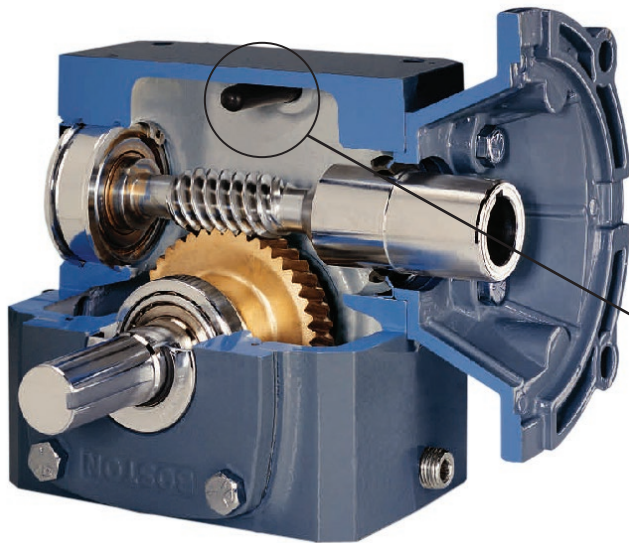

NOTE
The gear reducer is supplied with a "PosiVent[®]". No vent plugs are required.

PosiVent Unique design incorporates a single seam construction. Factory filled with synthetic lubrication for universal mounting. Lubed for life, no oil changes are required.

To expedite the installation and start-up process, all gear reducers are shipped filled with oil. The reducers are sealed and lubed for life and require no oil changes.

PREPARING FOR INITIAL START-UP



⚠ DANGER
WARN ALL PERSONNEL TO KEEP CLEAR OF CONVEYOR DURING UNIT START-UP
Electrical controls must be designed by a qualified electrical engineer to ensure that appropriate safety features (emergency stops, pull cords, switches, etc.) are installed on unit for safe operation. Before conveyor start-up, all operators and other personnel coming in contact with unit must be properly trained and must have read accompanying Tech Handbook.

Before conveyor start-up, all operators and other personnel coming in contact with unit must be properly trained and must have read accompanying Tech Handbook.

Provisions must be in order to instruct all personnel coming in contact with conveyor on the location of emergency stops, pull cords, etc.

A routine maintenance program should

be implemented before unit is placed into operation so that fundamental unit components are attended to. This maintenance program should include an inspection to ensure that any dangerous or hazardous operating conditions are noted and IMMEDIATELY corrected, as well as including electrical and mechanical unit inspections and corrections.

Finally, when conveyor is initially started, an immediate visual inspection should include motor, gear reducer, belt tracking (discussed in following section under "Belt Tracking") and related adjustments noted in handbook for unit/component corrections.

MAINTENANCE SAFETY PRECAUTIONS BEFORE PERFORMING MAINTENANCE

WARNING

Only trained personnel shall perform maintenance functions. Before maintenance operations are performed, conveyor must be shut "OFF" and disconnects locked in the "OFF" position to prevent unit from unauthorized start-up.

One of the most important guidelines for maximizing conveyor operation and personnel safety is to implement a regular maintenance schedule and train personnel on the appropriate needs of the specific unit.

Only trained personnel shall perform maintenance functions. Before maintenance operations are performed, conveyor must be shut "OFF" and disconnects locked in the "OFF" position to prevent unit from unauthorized start-up during maintenance. All personnel should be informed of the safety procedures associated with unit maintenance and performance.

Do not perform any work on conveyors or conveyor system while in operation unless it is impossible to otherwise conduct adjustment, lubrication or other maintenance function. Only experienced, trained personnel possessing advanced hazards-training should attempt such critical operations.

MAINTENANCE AND FOLLOW-UP DETAILS

WARNING

Only trained personnel shall perform maintenance functions. When maintenance is completed, only authorized personnel shall be permitted to start conveyor following maintenance or other emergency shut-off.

While performing maintenance do not wear loose clothing. Immediately report any hazardous conditions--sharp edges, pinch (or nip) points or other conditions that may result when several manufacturers supply machinery which may create operating hazards.

When using mechanical aids such as hoists, cables, or cranes exercise extreme caution to prevent damage to conveyors or other integrated machinery which may create a working hazard when maintenance is completed and units are in operation.

Clean up any spilled lubricants or other materials used in the maintenance process or those which may be deposited during unit operation. Eliminating poor housekeeping practices increases unit efficiency while creating safer personnel working conditions.

After maintenance, conduct visual inspection to ensure that all

safety devices and guards have been replaced. Confirm that all units are clear of tools, debris or other items. Before starting conveyor, check condition of conveyor warning labels (see "WARNING LABELS" at front of handbook). If labels have been destroyed or are not clearly legible, call 870.483.7631 to receive replacement labels. Placement of warning labels is critical to avoid unauthorized unit operation which may result in hazardous working conditions for all related personnel coming in contact with conveyor.

Warn personnel that conveyor is being prepared for start-up and to stay clear of unit. Do not start conveyor until all personnel are clear. When maintenance is completed, only authorized personnel shall be permitted to start conveyor following maintenance or other emergency shut-off.

MAINTENANCE AND LUBRICATION

PERIODIC MAINTENANCE SCHEDULE

MODEL NO. _____

WEEKLY RECOMMENDED MAINTENANCE SCHEDULE*	
COMPONENT	DETAIL OF MAINTENANCE
Pillow Block/Flange Bearings	Lubricate in dirty, dusty or moist/wet conditions
Unit Safety Check	Confirm placement of all guards, pop out rollers, warning labels & check for loose bolts, nip points & other hazards.

MONTHLY RECOMMENDED MAINTENANCE SCHEDULE*	
COMPONENT	DETAIL OF MAINTENANCE
Gear Reducer	Check for leaks.
Pillow Block / Flange Bearings	Lubricate (normal conditions).
Drive Chain	Check for proper operating tension and for overall wear and lubricate as needed.
Drive Sprockets	Check for overall wear & re-tighten set screws.

PERIODIC RECOMMENDED MAINTENANCE SCHEDULE*	
COMPONENT	DETAIL OF MAINTENANCE
Gear Reducer	Check for leaks.
Drive Chain	Clean (brush in solvent) & re-lubricate by applying lubricant to inside of chain with brush or spout can at 2000 hour intervals
Motor	Check & clear motor ventilation openings at 500 hour intervals. Check misc. operating conditions (normal heat & noise)

*All charts are for guidelines in normal operating or 'as noted' conditions. Severe applications may warrant additional maintenance.

MAINTENANCE AND LUBRICATION

RECOMMENDED LUBRICANTS

MISC. LUBRICANTS	
LUBRICANT	BRAND/DESCRIPTION
General Purpose Grease (For -30°F to 300°F operation)* For Extreme Temperature Operation (-90°F to 350°F operation)*	Shell Dolium R (Shell Oil Co.) (or suitable equivalent) Mobiltemp SHC-32 (Mobil Oil Corp.) (or suitable equivalent)
Washdown Application* (-30°F to 225°F operation) (May require special consideration--consult factory)	Shell Alvania No. 3 (Shell Oil Co.) (or suitable equivalent)
General Purpose Oil	SAE 10; SAE 20 or SAE 30

***NOTE:** Temperatures listed indicate the nominal operational temperature for the specific **lubricant** listed. This does not imply that the bearing housing, seals or any other conveyor unit component is rated to operate in this specific temperature range or environment. 250°F is the maximum operating temperature for standard bearing lubricants and bearing components. Although various lubricants may enhance bearing operation, special-order bearings may be required to achieve optimal bearing performance. For additional information, consult factory.

TROUBLE SHOOTING AND REPLACEMENT PARTS

TROUBLE SHOOTING / SERIAL PLATE

TROUBLE SHOOTING		
TROUBLE	PROBABLE CAUSE	REMEDY
Motor & gear reducer running excessively hot, repeated stalling or hard to start	A. Drag on conveyor B. Frozen sprocket C. Frozen roller D. Overload E. Electrical	A. Inspect entire conveyor for obstruction causing drag on chain. B. Check and inspect all sprockets and bearings. Replace sprockets failing to rotate or that are difficult to rotate. C. Check all rollers for rotation. D. Reduce cause and/or increase motor horsepower. E. Check wiring and circuits, take ampere reading, replace motor if necessary.
Motor & gear reducer makes excessive noise	A. Damaged gears B. Faulty bearing	A. Replace unit. B. Replace bearing.
Drive chain, conveying chain or sprockets experience excessive wear	A. Excessive chain tension B. Sprockets misaligned C. Chain not lubricated D. Damaged sprocket or chain E. Misalignment of chain guard F. Dirty chain	A. Reduce chain tension. B. Realign with straight edge across sprocket faces. C. Lubricate chain with approved lubricant, wipe away excess lubricant. D. Replace damaged component. E. Adjust chain guard assembly as necessary. F. Clean thoroughly and lubricate with approved lubricant.
Drive chain, conveying chain or sprockets make excessive noise	A. Insufficient chain tension B. Chain not adequately lubricated C. Sprockets misaligned	A. Adjust chain tension. B. Lubricate chain with approved lubricant, wipe away excess lubricant. C. Realign sprockets with straight edge across sprocket faces.
Pulsating chain	A. Insufficient chain tension B. Misalignment of chain guard C. Overload	A. Adjust chain tension. B. Adjust chain guard assembly as necessary. C. Inspect for obstruction to or drag on conveyor.
Broken chain	A. Frozen bearing or sprocket shaft B. Worn or damaged chain C. Obstructed or jam	A. Inspect for damaged bearings, replace if necessary. Replace links as required. B. Replace chain as required. C. Remove obstruction to clear jam.
Sprocket loose on shaft	A. Loose set screws B. Worn or damaged key	A. Realign sprockets with straight edge and tighten set screws. B. Replace with new key.
Excessive slack in chain	A. Normal wear	A. Expect rapid chain growth in first two weeks of operation. Adjust chain tension.

ORDERING REPLACEMENT PARTS

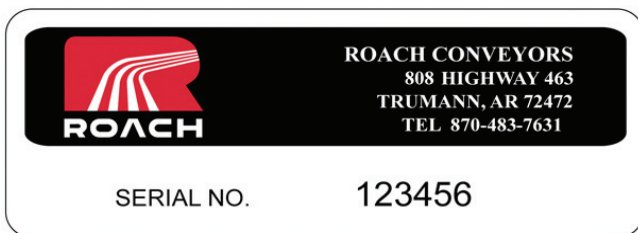

To order any replacement parts or when calling for assistance with any powered conveyor, **ALWAYS** provide conveyor serial number. This aluminum plate (shown at left) is placed on the conveyor frame near the location of the drive assembly.

To order replacement parts or add-on components, contact the Roach distributor who originally furnished conveyor if possible. If this is not possible, contact the National Sales Office at 870-483-7631 for the name of the authorized Roach distributor in your area. Have conveyor serial number **BEFORE** calling. Refer to unit drawings (in rear section of handbook) for part numbers if ordering replacement parts.

MODEL 192CDLR

PARTS LIST FOR UNDERNEATH AND SIDE MOUNT DRIVE

ITEM#	DESCRIPTION
1	End Bed Section Assembly
2	Bolt-in Butt Coupling (3-1/2")
3	Bolt-in Butt Coupling (5-1/2")
4	Chain Guard End Cover
5	Channel Cross member
6	Tread Roller Assembly
7	5-1/2" Side Channel
8	3-1/2" Side Channel
9	Bottom Chain Guard
10	Top Chain Guard
11	Chain Loops (Specify Roller Center)
12	Intermediate Bed Section Assembly
13	Full Length Bed Assembly
14	Bearing Hole Cover Plate
15	Drive Roller Clip
16	Drive Roller Assembly
17	5-1/2" Drive Side Channel
18	1-3/16" Bore Bearing
19	End Bed Section Assembly
20	Intermediate Bed Section Assembly
21	Reducer
22	Motorbase Stiffener Assembly (1HP+)
23	Reducer Push Plate Ass'y
24	Sidemount Motorbase Plate
25	Sidemount Chain Guard Assembly
26	Motor (Specify HP)
27	Chain Guard Mount (LH/RH)
28	Motorbase Stiffener Assembly (1HP+)
29	Reducer Push Plate Assembly
30	Underneath Motorbase Plate
31	Chain Guard Assembly

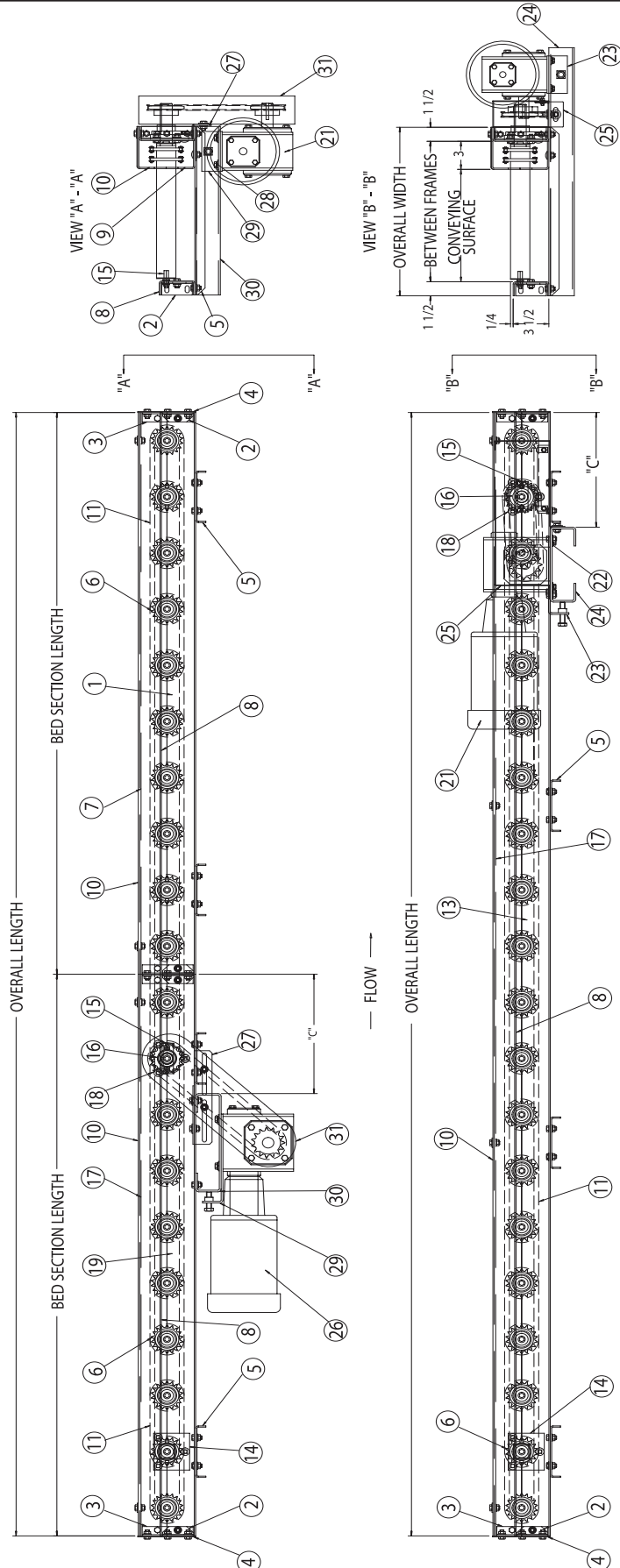

Specify **Unit Serial Number** when ordering replacement parts to ensure proper allocation of components (See Ordering Replacement Parts on page 13).

Recommended Spare Parts are shown in red. Charted are item no. and part description

When ordering use example below.

Example: Need a replacement tread roller for a 192CDLR.

Part No: SN 123456 - 6 - Tread Roller Assembly

ROACH CONVEYORS
 808 HIGHWAY 463
 TRUMANN, AR 72472
 TEL. 870-483-7631

SERIAL NO. **123456**

MODEL 251CDLR

PARTS LIST FOR UNDERNEATH AND SIDE MOUNT DRIVE

ITEM#	DESCRIPTION
1	End Bed Section Assembly
2	Bolt-in Butt Coupling (4")
3	Chain Guard End Cover
4	Bolt-in Butt Coupling (6")
5	Channel Cross member
6	TREAD ROLLER ASSEMBLY
7	BOTTOM CHAIN GUARD
8	TOP CHAIN GUARD
9	6" SIDE CHANNEL
10	4" SIDE CHANNEL
11	2" Wide Uhmw Tape (12" RC Only)
12	Chain Loops (Specify Roller Center)
13	Intermediate Bed Section Assembly
14	Full Length Bed Assembly
15	Bearing Hole Cover Plate
16	Drive Roller Clip Weld Assembly
17	Drive Roller Assembly
18	6" Drive Side Channel
19	4 Hole 1-7/16" Bore Bearing
20	End Bed Section Assembly
21	Intermediate Bed Section Assembly
22	Reducer
23	Motorbase Stiffener Assembly (1HP+)
24	Reducer Push Plate Assembly
25	Sidemount Motorbase Plate
26	Sidemount Chain Guard Assembly
27	Motor (Specify HP)
28	Chain Guard Angle Mount
29	Motorbase Stiffener Assembly (1HP+)
30	Reducer Push Plate Assembly
31	Underneath Motorbase Plate
32	Chain Guard Assembly

Specify **Unit Serial Number** when ordering replacement parts to ensure proper allocation of components (See Ordering Replacement Parts on page 13).

Recommended Spare Parts are shown in red. Charted are item no. and part description

When ordering use example below.

Example: Need a replacement sidemount motorbase plate for a 251CDLR.

Part No: SN 123456 - 25 - Sidemount Motorbase Plate



ROACH CONVEYORS
 808 HIGHWAY 463
 TRUMANN, AR 72472
 TEL. 870-483-7631

SERIAL NO. **123456**

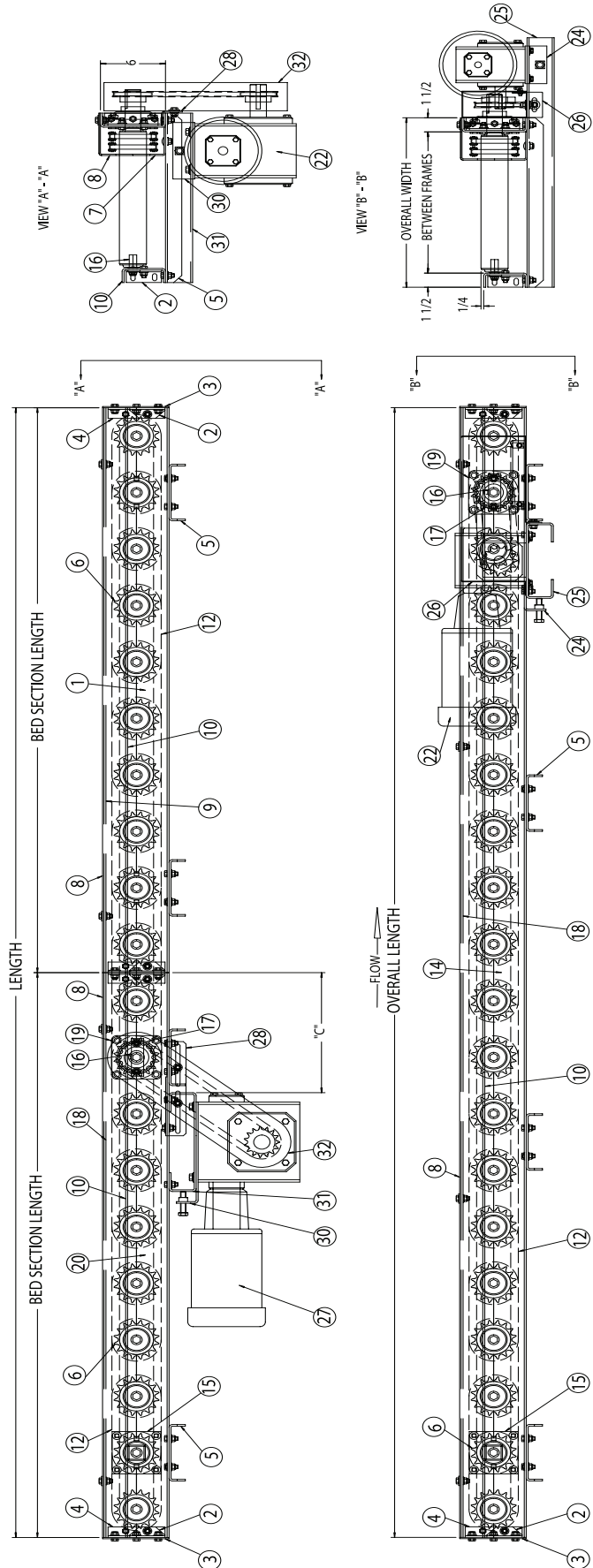

MODEL 251CDLR/297CDLR (STRUCTURAL)

PARTS LIST FOR UNDERNEATH AND SIDE MOUNT DRIVE

ITEM#	DESCRIPTION
1	End Bed Section Assembly
2	Chain Guard End Cover
3	Channel Cross member
4	Tread Roller Assembly
5	Bed Spacer Roller Assembly
6	Bottom Chain Guard
7	Top Chain Guard
8	6" Side Channel Weld Assembly
9	4" Side Channel Weld Assembly
10	2" Wide Uhmw Tape (12" RC Only)
11	Assembled chain Loops
12	Intermediate Bed Section Assembly
13	Full Length Bed Assembly
14	Bearing Hole Cover Plate
15	Drive Roller Clip Weld Assembly
16	Drive Roller Assembly
17	6" Drive Side Channel Weld Assembly
18	1-7/16" Bore 4-hole Bearing
19	End Bed Section Assembly
20	Intermediate Bed Section Assembly
21	Reducer
22	Motorbase Stiffener Assembly (1HP+)
23	Reducer Push Plate Assembly
24	Sidemount Motorbase Plate
25	Sidemount Chain Guard Assembly
26	Motor (Specify HP)
27	Chain Guard Angle Mount
28	Motorbase Stiffener Assembly (1HP+)
29	Reducer Push Plate Assembly
30	Underneath Motorbase Plate
31	Chain Guard Assembly

Specify **Unit Serial Number** when ordering replacement parts to ensure proper allocation of components (See Ordering Replacement Parts on page 13).

Recommended Spare Parts are shown in red. Charted are item no. and part description

When ordering use example below.

Example: Need a replacement bearing hole cover plate for a 297CDLR.

Part No: SN 123456 - 14 - Bearing Hole Cover Plate



ROACH CONVEYORS
 808 HIGHWAY 463
 TRUMANN, AR 72472
 TEL. 870-483-7631

SERIAL NO. **123456**

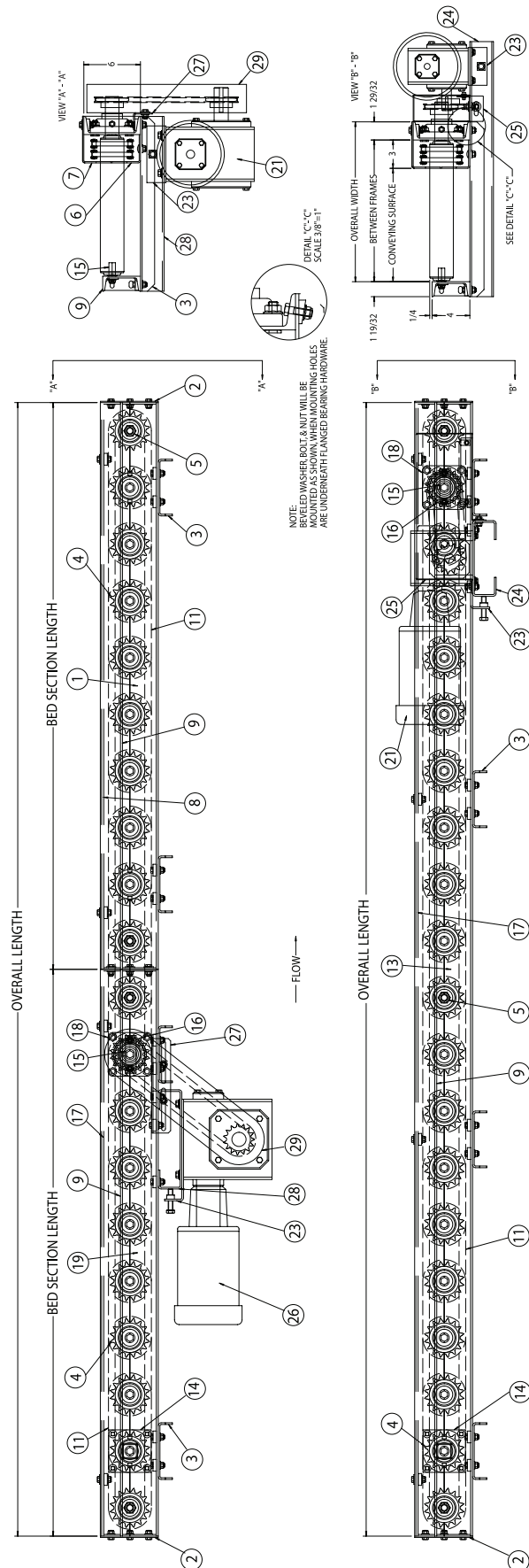

MODEL 3530CDLR (STRUCTURAL) PARTS LIST FOR UNDERNEATH AND SIDE MOUNT DRIVE

ITEM#	DESCRIPTION
1	End Bed Section
2	Chain Guard End Cover
3	8" Side Channel Weld Assembly
4	6" Side Channel Weld Assembly
5	Channel Cross member
6	Tread Roller Assembly
7	Bed Spacer Roller Assembly
8	Bottom Chain Guard
9	Top Chain Guard
10	Chain Loops (Specify Roller Center)
11	Intermediate Bed Section Assembly
12	Full Length Bed Assembly
13	Bearing Hole Cover Plate Assembly
14	8" Drive Side Channel Assembly
15	6" Drive Channel Assembly
16	Drive Roller Assembly
17	2 Hole 1-3/16" Bore Bearing
18	4 Hole 1-7/16" Bore Bearing
19	End Bed Section Assembly
20	Intermediate Bed Section Assembly
21	Reducer
22	Motorbase Stiffener Assembly (1HP+)
23	Reducer Push Plate Assembly
24	Sidemount Motorbase Plate
25	Sidemount Chain Guard Assembly
26	Motor (Specify HP)
27	Chain Guard Angle Mount
28	Motorbase Stiffener Assembly
29	Reducer Push Plate Assembly
30	Underneath Motorbase Plate
31	Chain Guard Assembly

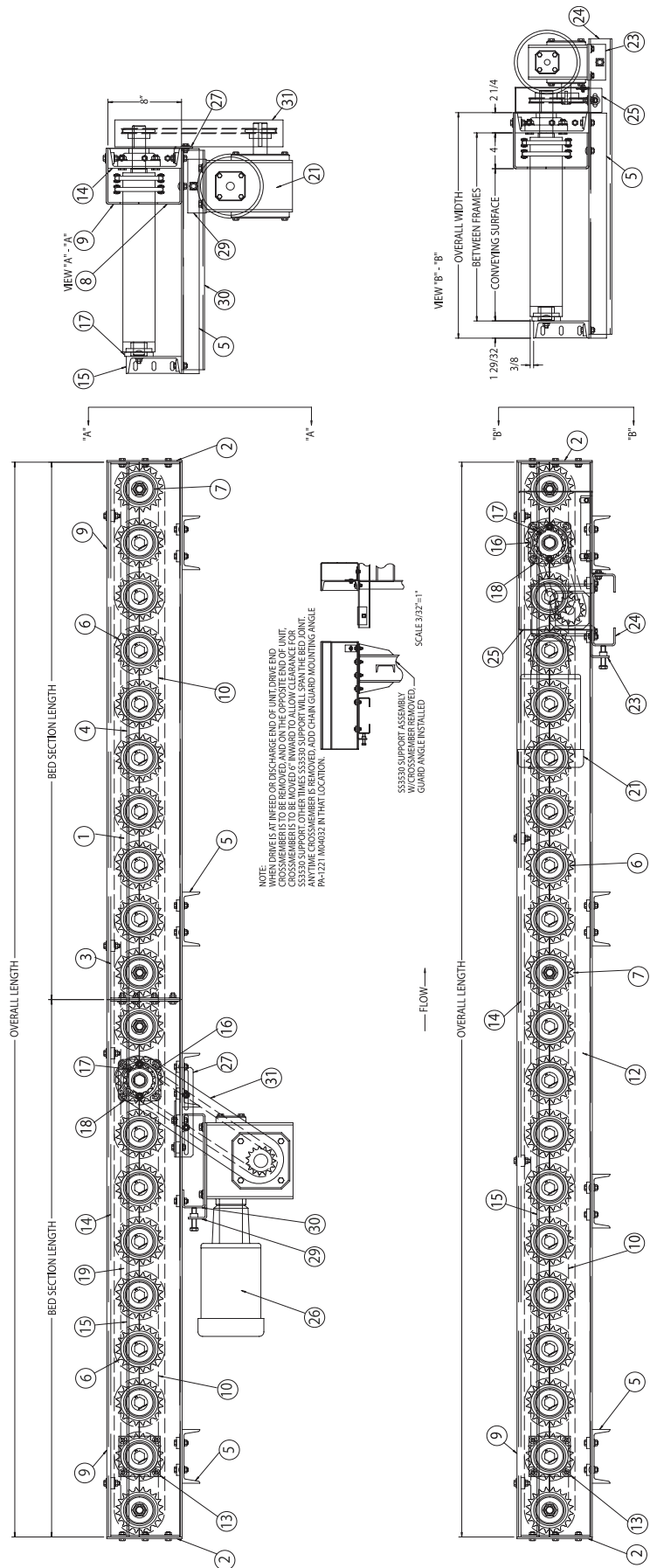

Specify **Unit Serial Number** when ordering replacement parts to ensure proper allocation of components (See Ordering Replacement Parts on page 13).

Recommended Spare Parts are shown in red. Charted are item no. and part description

When ordering use example below.

Example: Need a replacement Drive Roller Assembly for a 3530CDLR.

Part No: SN 123456 - 16 - Drive Roller Assembly



ROACH CONVEYORS
 808 HIGHWAY 463
 TRUMANN, AR 72472
 TEL. 870-483-7631

SERIAL NO. **123456**



ROACH CONVEYORS

WARRANTY

- Materials used by Roach Conveyors are of good quality.
- Any part proving to be defective in materials or workmanship upon Roach inspection, will be replaced at NO cost, FOB, Trumann, Arkansas, for one year. Installation expense will be paid by others.
- Roach liability includes furnishing said part or parts; Roach is not liable for consequential damages, such as loss of profit, delays or expenses incurred by failure of said part or parts.
- Failure due to abuse, incorrect adjustments, exposure to corrosive or abrasive environment or operation under damp conditions does not constitute failure due to defects in workmanship or materials.
- Component parts not manufactured by Roach (motors, gear reducers, etc.) will be repaired or replaced at the option of their manufacturer. Contact nearest authorized service center for all warranty claims.

NOTE: Motors or gear reducers tampered with before inspection shall be considered free of ALL Warranty Claims.

--All specifications are subject to change without notice--

--Drawings are intended for illustration ONLY and are not to scale--

808 HIGHWAY 463
TRUMANN, ARKANSAS 72472-1310
Tel 870-483-7631 Fax 870-483-7049
info@roachconveyors.com
www.roachconveyors.com



ROACH
C O N V E Y O R S[®]

808 HIGHWAY 463
TRUMANN, ARKANSAS 72472-0580
Tel 870-483-7631 Fax 870-483-7049
roachconveyors.com